

●PHONE JACK

SJ9 SERIES

ENGINEERING DRAWING

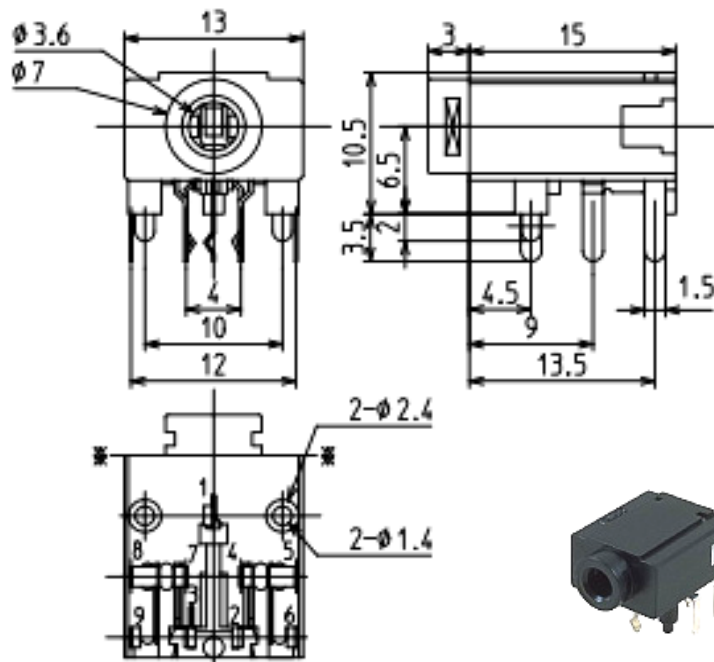
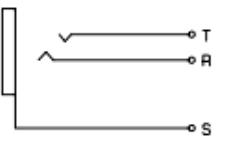
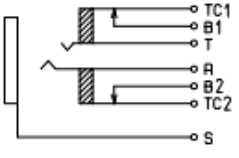
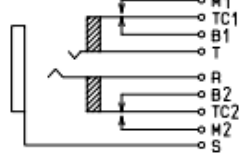
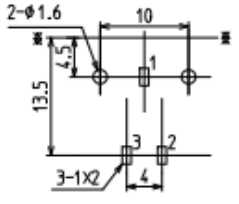
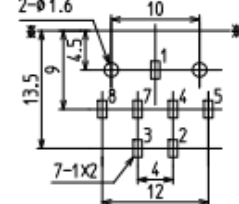
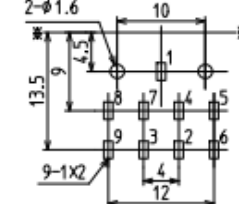

CIRCUIT STRUCTURE	STEREO					
	3A WITHOUT SW	3C WITH SW	3E WITH SW			
						
REFERENCE AGREEMENT P.C.B	DIP SIDE VIEW					
						
	WITHOUT SLEEVE	YKB21-5406N	WITHOUT SLEEVE	YKB21-5352N	WITHOUT SLEEVE	YKB21-5344N
	WITH SLEEVE	Ni YKB21-5413N Au YKB21-5414N	WITH SLEEVE	Ni YKB21-5343N Au YKB21-5399N	WITH SLEEVE	Ni YKB21-5345N Au YKB21-5398N